



# Silbertrends Silver trends

Tendances Actuelles en Argent





versilbert / silverplated / argenté



matt versilbert / mat silverplated / argenté mat



weißbronze / whitebronze / bronze blanc



rhodiniert / rhodiumplated / rhodiné



schwarz-ruthenium / black-ruthenium / noir-ruthenium



antik-versilbert / antique silverplated / argenté vieilli



antik-vergoldet / antique goldplated / doré vieilli



vergoldet # 122 / goldplated # 122 / doré # 122



matt vergoldet # 122 / mat goldplated # 122 / doré mat # 122



vergoldet # 109 / goldplated # 109 / doré # 109



matt vergoldet # 109 / mat goldplated # 109 / doré mat # 109



vergoldet # 124 / goldplated # 124 / doré # 124



matt vergoldet # 124 / mat goldplated # 124 / doré mat # 124



vergoldet # 206 / goldplated # 206 / doré # 206



matt vergoldet # 206 / mat goldplated # 206 / doré mat # 206

Farbabweichungen möglich / color differences possible / couleurs peuvent varier

# Basic-Classic-Collection



08

## Ankerketten / Cable chains / Chaînes forçat

Ankerketten - rund  
Cable chains - round  
Chaînes forçat - rondes

SI 04/6 ca. 4,9 gr/m

SI 05/6 ca. 8,2 gr/m

SI 06/6 ca. 11,7 gr/m

SI 07/6 ca. 16,5 gr/m

SI 08/6 ca. 20 gr/m

SI 10/6 ca. 34,6 gr/m

SI 12/6 ca. 42 gr/m

SI 15/6 ca. 70 gr/m

Ankerketten - rund  
Cable chains - round  
Chaînes forçat - rondes

SI 17/6 ca. 91,9 gr/m

SI 20/6 ca. 126 gr/m

SI 23/6 ca. 192,8 gr/m

SI 25/6 ca. 184,1 gr/m

SI 35/6 ca. 389 gr/m

Basic-Classic-Collection

# Ankerketten / Cable chains / Chaînes forçat

Ankerketten - rund  
Cable chains - round  
Chaînes forçat - rondes

SI 000281 ca. 12 gr/m

SI 000282 ca. 20,5 gr/m

SI 000283 ca. 32,5 gr/m

SI 000277 ca. 55,5 gr/m

SI 000585 ca. 24,7 gr/m

SI 10/6/SL ca. 20 gr/m

SI 12/6/W ca. 37,9 gr/m

SI 18/6/WA ca. 72,9 gr/m

SI 40870 ca. 12 gr/m

Ankerketten - 4-fach diamantiert  
Cable chains - 4-sides diamond cut  
Chaînes forçat - 4 fois diamantées

SI 035/6/D4 ca. 3,4 gr/m

SI 05/6/D4 ca. 7,7 gr/m

SI 06/6/D4 ca. 10,5 gr/m

SI 08/6/D4 ca. 20 gr/m

SI 10/6/D4 ca. 28,5 gr/m

SI 12/6/D4 ca. 44,1 gr/m

SI 15/6/D4 ca. 71,9 gr/m

SI 15/6/LA/D4 ca. 71,9 gr/m

SI 17/6/D4 ca. 74,63 gr/m

SI 20/6/D4 ca. 104,4 gr/m

SI 25/6/D4 ca. 177,1 gr/m

SI 30/6/D4 ca. 215,9 gr/m

Ankerkette - 6-fach diamantiert  
Cable chain - 6-sides diamond cut  
Chaîne forçat - 6 fois diamantées

SI 23/5/6D ca. 152,2 gr/m

Ankerketten - 4-kant  
Cable chains - square wire  
Chaînes forçat - fil carré

SI 15/5/E ca. 63,1 gr/m

SI 000428 ca. 251,3 gr/m

SI 000431 ca. 242,5 gr/m

SI 000454 ca. 87 gr/m

SI 000547 ca. 33 gr/m

SI 10/11 ca. 32 gr/m

SI 15/11 ca. 73 gr/m

SI 20/11 ca. 162,75 gr/m

Ankerketten - gedrückt  
Cable chains - hammered  
Chaînes forçat - pressées

SI 000469 ca. 71,0 gr/m

SI 000469/A ca. 73,0 gr/m

SI 000469/AG ca. 71,0 gr/m

SI 000473 ca. 47,3 gr/m

SI 000474 ca. 34,1 gr/m

# Ankerketten / Cable chains / Chaînes forçat

Ankerketten - flach gewalzt  
Cable chains - flattened  
Chaînes forçat - aplaties au rouleau

SI 03/5 ca. 2,9 gr/m

SI 04/5 ca. 4,9 gr/m

SI 05/5 ca. 7,8 gr/m

SI 05/5/L ca. 6,5 gr/m

SI 06/5 ca. 11,5 gr/m

SI 07/5 ca. 15,5 gr/m

SI 08/5 ca. 19,7 gr/m

SI 08/5/A ca. 17,1 gr/m

SI 10/5 ca. 34,4 gr/m

SI 10/5/A ca. 30,4 gr/m

SI 12/5 ca. 48,9 gr/m

SI 15/5 ca. 74 gr/m

SI 30/5 ca. 270 gr/m

SI 10/6/SL/G ca. 17,6 gr/m

SI 13/6/LA/G ca. 33,5 gr/m

SI 000585/G ca. 23,5 gr/m

SI 000586/G ca. 10,4 gr/m

SI 12/6/FG ca. 43,5 gr/m

SI 23/5/4F ca. 157,9 gr/m

Ankerkette - flach gewalzt / geschliffen  
Cable chain - flattened / cut  
Chaîne forçat - aplatie au rouleau / limée

SI 15/5/6 ca. 63,7 gr/m

Ankerketten - halbrund  
Cable chains - half-round  
Chaînes forçat - semi-circulaires

SI 3/6/OV ca. 72 gr/m

SI 15/60 ca. 140 gr/m

SI 000521 ca. 92,5 gr/m

SI 18/90 ca. 185 gr/m

SI 35/6/HR ca. 344,7 gr/m

Ankerkette - rund gedrückt  
Cable chain - round hammered  
Chaîne forçat - ronde pressée

SI 000519 ca. 8,4 gr/m

Ankerketten - oval gedrückt  
Cable chains - oval hammered  
Chaînes forçat - ovaies pressées

SI 04/8/0 ca. 4,9 gr/m

SI 07/8/0 ca. 15,2 gr/m

SI 10/8/0/B ca. 33,2 gr/m

SI 12/8/0/B ca. 45,8 gr/m

Ankerketten - rund geschlagen  
Cable chains - round beaten  
Chaînes forçat - rondes battues

SI 08/6/RG ca. 18,4 gr/m

SI 10/6/RG ca. 27,1 gr/m

SI 15/6/RG ca. 64,2 gr/m

SI 18/6/RG ca. 88,8 gr/m

SI 20/6/RG ca. 116,1 gr/m

SI 10/PA ca. 6,5 gr/m

SI 45/PA ca. 115,1 gr/m

# Ankerketten / Cable chains / Chaînes forçat

Ankerketten - seitlich diamantiert  
Cable chains - diamond cut on the sides  
Chaînes forçat - diamantées latéralement

SI 05/6/SD ca. 7,7 gr/m

SI 06/6/SD ca. 8,6 gr/m

SI 08/6/SD ca. 19,7 gr/m

SI 10/6/SD ca. 30,1 gr/m

SI 12/6/SD ca. 42,2 gr/m

SI 15/6/SDB ca. 64,7 gr/m

SI 20/6/SD ca. 111,3 gr/m

SI 25/6/SD ca. 164,8 gr/m

SI 30/6/SD ca. 238 gr/m

Ankerketten - viereckig  
Cable chains - square  
Chaînes forçat - carrées

SI 12/6/V ca. 46,2 gr/m

SI 12/6/V/WA ca. 37,0 gr/m

SI 15/6/RT ca. 54,5 gr/m

Ankerketten - ziseliert  
Cable chains - engraved  
Chaînes forçat - gravées

SI 08/6/Z3/D ca. 15,0 gr/m

SI 10/6/W/Z3 ca. 22,9 gr/m

SI 12/6/WA/Z3 ca. 49,0 gr/m

SI 15/6/RT/W/Z3 ca. 41,8 gr/m

SI 20/6/Z3 ca. 110,0 gr/m

SI 000813 ca. 246,5 gr/m

Ankerketten - ziseliert / glatt  
Cable chains - engraved / smooth  
Chaînes forçat - gravées / lisses

SI 15/6/A1Z3 ca. 66,0 gr/m

SI 25/6/A1Z ca. 223,4 gr/m

SI 000703 ca. 93,0 gr/m

SI 000755 ca. 115,0 gr/m

SI 000757 ca. 146,0 gr/m

Sonstige Ankerketten  
Other cable chains  
Autres chaînes forçat

SI 06/6/RTG ca. 7,8 gr/m

SI 000549 ca. 3,3 gr/m

SI 000550 ca. 4,1 gr/m

SI 000551 ca. 4,1 gr/m

SI 000456/G ca. 49,5 gr/m

SI 000456/Z3 ca. 48,0 gr/m

SI 000456/BI ca. 24,0 gr/m

SI 000583 ca. 21,6 gr/m

SI 000583/G ca. 24,6 gr/m

SI 55/5/F ca. 8,9 gr/m

SI 55/5/FZ ca. 8,8 gr/m

SI 000905 ca. 5,2 gr/m

SI 000906 ca. 9,1 gr/m

# Langankerketten / Long cable chains / Chaînes forçat espacées

Langankerketten  
Long cable chains  
Chaînes forçat espacées

SI 06/10/L ca. 9,3 gr/m

SI 08/10/L ca. 16,2 gr/m

SI 10/10/L ca. 25,7 gr/m

SI 10/6/L/AVG ca. 26 gr/m

SI 000412 ca. 47,5 gr/m

SI 000412/Z3 ca. 50 gr/m

Langankerketten - 4-kant  
Long cable chains - square wire  
Chaînes forçat espacées - fil carré

SI 10/10 ca. 26 gr/m

SI 12/10 ca. 37,8 gr/m

Langankerketten - halbrund  
Long cable chains - half-round  
Chaînes forçat espacées - semi-circulaires

SI 05/6/LHR/B ca. 5,9 gr/m

SI 08/6/LHR ca. 8,53 gr/m

Langankerkette - ziseliert  
Long cable chain - engraved  
Chaîne forçat espacée - gravée

SI 12/6/LHRZ ca. 21,1 gr/m

Langankerketten - rund  
Long cable chains - round  
Chaînes forçat espacées - rondes

SI 07/6/L/A ca. 11,0 gr/m

SI 10/6/L/A ca. 26,0 gr/m

SI 13/6/L/A ca. 33 gr/m

Langankerketten - rund  
Long cable chains - round  
Chaînes forçat espacées - rondes

SI 000436/R ca. 7,0 gr/m

SI 08/6/LA/X ca. 14,2 gr/m

SI 10/6/LA/X ca. 23,2 gr/m

SI 10/6/SL/A ca. 21,0 gr/m

SI 09/6/SW/A ca. 18,5 gr/m

SI 130/6/L/A ca. 34,7 gr/m

SI 18/6/L/A ca. 61,6 gr/m

SI 05/6/L ca. 5,7 gr/m

SI 06/6/L ca. 8,99 gr/m

SI 10/6/LB ca. 25,5 gr/m

SI 15/6/LA ca. 65,8 gr/m

SI 20/6/LA ca. 120 gr/m

SI 25/6/LA ca. 169,9 gr/m

SI 30/6/LA ca. 259,7 gr/m

SI 35/6/LA ca. 370 gr/m



## Weit-Ankerketten / Wide cable chains / Chaînes forçat étendues

Weit-Ankerketten - rund  
Wide cable chains - round  
Chaînes forçat étendues - rondes

SI 03/6/W	ca. 2,6 gr/m
SI 04/6/W	ca. 4,6 gr/m
SI 05/6/W	ca. 7,8 gr/m
SI 06/6/W	ca. 11,7 gr/m
SI 06/6/W/A	ca. 10,0 gr/m
SI 08/6/W	ca. 18,5 gr/m
SI 10/6/W	ca. 26,3 gr/m
SI 12/6/WA	ca. 39,0 gr/m
SI 18/6/W	ca. 80,0 gr/m
SI 20/6/W	ca. 116,7 gr/m
SI 35/6/W	ca. 286,3 gr/m

Weit-Ankerketten - flachgewalzt  
Wide cable chains - flattened  
Chaînes forçat étendues - aplaties au rouleau

SI 03/5/W	ca. 2,4 gr/m
SI 04/5/W	ca. 4,3 gr/m
SI 05/5/W	ca. 7,2 gr/m
SI 06/5/W	ca. 12,0 gr/m
SI 12/6/WA/G	ca. 39,0 gr/m
SI 18/6/WA/G	ca. 68,2 gr/m
SI 15/5/W	ca. 52,8 gr/m
SI 20/5/W	ca. 112,0 gr/m

## Zwillingsanker / Twin cable / Forçat jumeau

Zwillingsanker - rund  
Twin cable - round  
Forçat jumeau - rond

SI 04/66	ca. 10,7 gr/m
SI 06/66	ca. 25,7 gr/m
SI 06/66/B	ca. 24,7 gr/m
SI 08/66	ca. 42,3 gr/m
SI 08/66/B	ca. 47,1 gr/m
SI 10/66	ca. 69,3 gr/m

Zwillingsanker - rund  
Twin cable - round  
Forçat jumeau - rond

SI 12/66	ca. 105,0 gr/m
SI 15/66	ca. 150,0 gr/m
SI 20/66	ca. 270,6 gr/m

## Zwillingsanker / Twin cable / Forçat jumeau

Zwillingsanker - ziseliert  
Twin cable - engraved  
Forçat jumeau - gravé

SI 08/66/Z3 ca. 42,9 gr/m

SI 10/66/L/Z3 ca. 65,7 gr/m

SI 10/66/Z3 ca. 66,4 gr/m

Zwillingsanker - ziseliert  
Twin cable - engraved  
Forçat jumeau - gravé

SI 15/66/8 ca. 153,0 gr/m

SI 20/66/8 ca. 261,0 gr/m

## Figaro-Anker / Figaro cable / Figaro forçat

Figaro-Ankerketten - rund  
Figaro cable chains - round  
Chaînes figaro forçat - rondes

SI 000325 ca. 51,9 gr/m

SI 000327 ca. 28,3 gr/m

SI 12/FIA/0 ca. 33,2 gr/m

SI 12/FI/0/A ca. 42,5 gr/m

SI 12/FI/1/A ca. 39,0 gr/m

SI 15/FI/RT/0/A ca. 48,4 gr/m

SI 15/FI/RT/1/A ca. 51,0 gr/m

SI 15/FI/RT/5/A ca. 51,8 gr/m

SI 15/FI/RT/7/A ca. 51,7 gr/m

SI 15/FIA/6 ca. 53,3 gr/m

SI 18/FIA/0 ca. 78,6 gr/m

SI 18/FIA/1 ca. 92,4 gr/m

Figaro-Ankerketten - rund  
Figaro cable chains - round  
Chaînes figaro forçat - rondes

SI 18/FIA/5 ca. 84,7 gr/m

SI 000345 ca. 23,5 gr/m

SI 000346 ca. 29,0 gr/m

SI 000814 ca. 14,2 gr/m

SI 10/FI/1/A ca. 28,0 gr/m

SI 10/FI/L/11 ca. 20,9 gr/m

SI 10/FI/L/11A ca. 20,9 gr/m

SI 10/FIA/11A ca. 21 gr/m

SI 45/FIA/13 ca. 5,3 gr/m

SI 45/FID/11 ca. 4,4 gr/m

SI 55/FIA/11 ca. 7,4 gr/m

SI 55/FIA/11/A ca. 7,1 gr/m

SI 55/FIA/13 ca. 7,4 gr/m

SI 08/FIE/11 ca. 16,0 gr/m

SI 000273/A ca. 62,0 gr/m

# Figaro-Anker / Figaro cable / Figaro forçat

Figaro-Ankerketten - rund / halbrund  
 Figaro cable chains - round / half-round  
 Chaînes figaro forçat - rondes / semi-circulaires

SI 08/FIA/11 ca. 13,7 gr/m

SI 08/FIEA/11 ca. 14,6 gr/m

SI 10/FIEA/11 ca. 21,4 gr/m

Figaro-Ankerketten - ziseliert  
 Figaro cable chains - engraved  
 Chaînes figaro forçat - gravées

SI 12/FIV/31/Z3 ca. 44,0 gr/m

SI 15/FIV/31/Z3 ca. 68,2 gr/m

SI 15/FIV/31/WZ3 ca. 68,8 gr/m

SI 000273/A/Z3 ca. 53 gr/m

SI 000273/Z3 ca. 58,4 gr/m

SI 000426 ca. 22 gr/m

SI 000468 ca. 46 gr/m

SI 000482 ca. 34,1 gr/m

Figaro-Ankerketten - 3-kant  
 Figaro cable chains - triangular  
 Chaînes figaro forçat - trois biseaux

SI 000581 ca. 32,6 gr/m

Figaro-Ankerketten - bauchig gedrückt / rund  
 Figaro cable chains - bellied hammered / round  
 Chaînes figaro forçat - pansues pressées / rondes

SI 45/FIF/11 ca. 4,9 gr/m

SI 45/FIF/13 ca. 5,1 gr/m

SI 55/FIF/13 ca. 7 gr/m

SI 10/FIEF/11 ca. 21 gr/m

Figaro-Ankerketten - flach gewalzt / halbrund eng  
 Figaro cable chains - flattened / half-round tight  
 Figaro forçat - aplaties au rouleau / semi-circulaires serrées

SI 08/FIEB/11 ca. 14,2 gr/m

SI 10/FIEB/11 ca. 21,7 gr/m

Figaro-Ankerkette - flach gewalzt / halbrund  
 Figaro cable chain - flattened / half-round  
 Figaro forçat - aplatie au rouleau / semi-circulaire

SI 08/FIB/11 ca. 13,6 gr/m

Figaro-Ankerketten - flach gewalzt / ziseliert / rund  
 Figaro cable chains - flattened / engraved / round  
 Figaro forçat - aplaties au rouleau / gravées / rondes

SI 45/FIC/11 ca. 4,3 gr/m

SI 45/FIC/13 ca. 4,3 gr/m

SI 45/FIE/13 ca. 4,9 gr/m

SI 55/FIC/11 ca. 6,7 gr/m

SI 55/FIC/13 ca. 7,3 gr/m

Figaro-Ankerketten - flach gewalzt / rund  
 Figaro cable chains - flattened / round  
 Chaînes figaro forçat - aplaties au rouleau / rondes

SI 45/FIB/11 ca. 4,5 gr/m

SI 45/FIB/13 ca. 5,3 gr/m

SI 45/FID/13 ca. 4,9 gr/m

SI 55/FIB/11 ca. 7 gr/m

SI 55/FIB/13 ca. 7,2 gr/m

## Figaro-Anker / Figaro cable / Figaro forçat

Figaro-Ankerketten - Sonstige  
Figaro cable chains - other  
Chaînes figaro forçat - autres

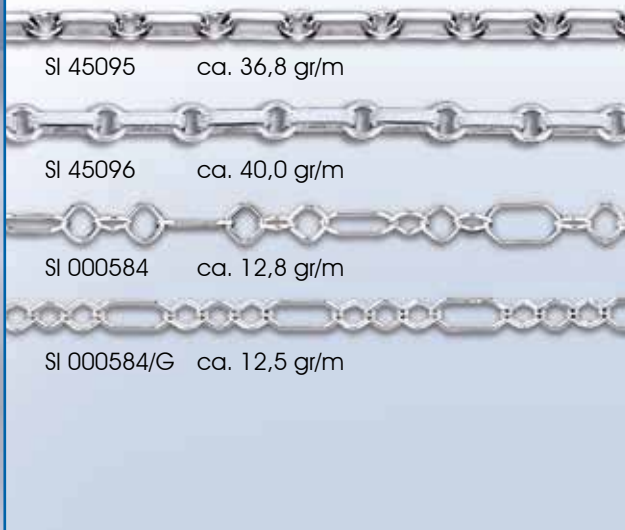

Figaro-Ankerketten - Sonstige  
Figaro cable chains - other  
Chaînes figaro forçat - autres



## Doppelanker / Double cable / Forçat double

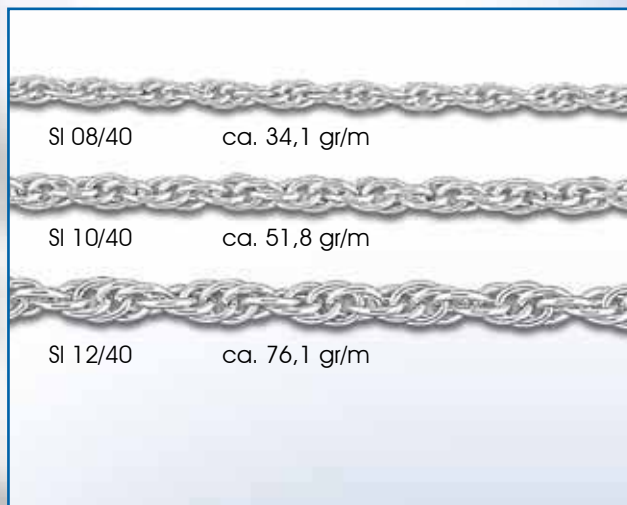

## Steg-Anker / Bar cable / Forçat marine

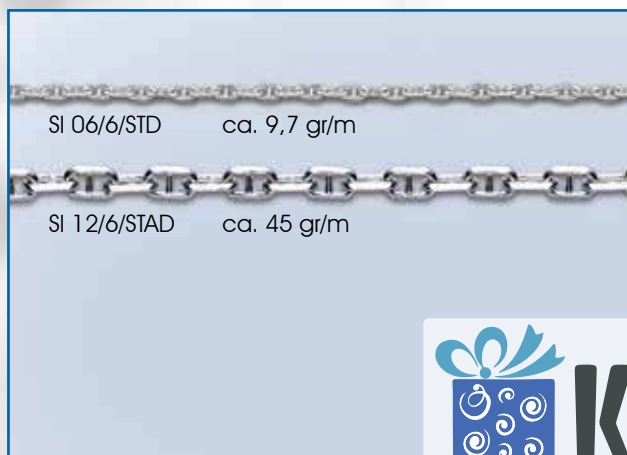
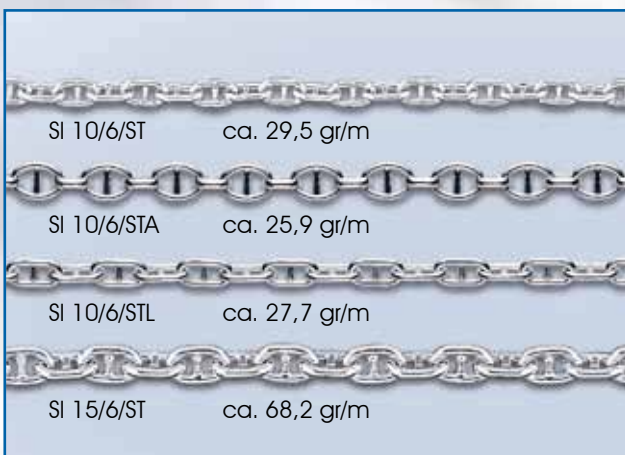

## Panzerketten / Curb chains / Chaînes gourmette

Panzerketten - rund  
Curb chains - round  
Chaînes gourmette - rondes

SI 025 ca. 1,8 gr/m

SI 03 ca. 3,1 gr/m

SI 04 ca. 5,1 gr/m

SI 05 ca. 8,4 gr/m

SI 06 ca. 11 gr/m

SI 07 ca. 16,8 gr/m

SI 08 ca. 20,3 gr/m

SI 10 ca. 33,1 gr/m

SI 12 ca. 48,5 gr/m

SI 13 ca. 57,3 gr/m

SI 15 ca. 66 gr/m

SI 17 ca. 96,2 gr/m

Panzerketten - rund  
Curb chains - round  
Chaînes gourmette - rondes

SI 18 ca. 111,7 gr/m

SI 20 ca. 140,1 gr/m

SI 23 ca. 183,2 gr/m

SI 25 ca. 224,9 gr/m

SI 30 ca. 307 gr/m

SI 35 ca. 426,4 gr/m

SI 40 ca. 541,4 gr/m

# Panzerketten / Curb chains / Chaînes gourmette

Panzerketten - 2-fach diamantiert  
Curb chains - 2-sides diamond cut  
Chaînes gourmette - 2 fois diamantées

SI 03/1/D ca. 2,7 gr/m

SI 04/1/D ca. 4,3 gr/m

SI 05/1/D ca. 7,8 gr/m

SI 06/1/D ca. 10,8 gr/m

SI 07/1/D ca. 15,4 gr/m

SI 08/1/D ca. 19,4 gr/m

SI 10/1/D ca. 33,5 gr/m

SI 12/1/D ca. 45,1 gr/m

SI 13/1/D ca. 52,2 gr/m

SI 15/1/D ca. 60 gr/m

SI 17/1/D ca. 84,8 gr/m

SI 20/1/D ca. 128 gr/m

SI 25/1/D ca. 201,5 gr/m

SI 30/1/D ca. 296,2 gr/m

SI 35/1/D ca. 393,5 gr/m

SI 40/1/D ca. 510,3 gr/m

Panzerketten - 4-fach diamantiert  
Curb chains - 4-sides diamond cut  
Chaînes gourmette - 4 fois diamantées

SI 08/1/1D ca. 19,2 gr/m

SI 10/1/1D ca. 29,1 gr/m

SI 12/1/1D ca. 40,6 gr/m

SI 13/1/1D ca. 48 gr/m

SI 15/1/1D ca. 73,2 gr/m

SI 17/1/1D ca. 88,1 gr/m

SI 20/1/1D ca. 118,5 gr/m

SI 25/1/1D ca. 183,4 gr/m

SI 30/1/1D ca. 271,5 gr/m

SI 35/1/1D ca. 385,6 gr/m

Panzerkette - 6-fach diamantiert  
Curb chain - 6-sides diamond cut  
Chaîne gourmette - 6 fois diamantées

SI 35/D6 ca. 283,7 gr/m

Panzerketten - flach geschliffen  
Curb chains - cut flat  
Chaînes gourmette - plates limées

SI 15/FG/1 ca. 60 gr/m

SI 20/FG/1 ca. 109 gr/m

# Panzerketten / Curb chains / Chaînes gourmette

Panzerketten - superflach  
Curb chains - super flat  
Chaînes gourmette - super-plates

SI 12/1D/FL	ca. 36 gr/m
SI 15/1D/FL	ca. 59 gr/m
SI 20/1D/FL	ca. 95,5 gr/m
SI 30/1D/FL	ca. 225 gr/m
SI 30/2/1D/FL	ca. 216,7 gr/m
SI 12/D/FL	ca. 33,0 gr/m
SI 15/D/FL	ca. 52,0 gr/m
SI 20/D/FL	ca. 80,0 gr/m
SI 18/2/LD/FL	ca. 56,0 gr/m
SI 20/2/LD/FL	ca. 64,0 gr/m

Panzerketten - superflach gedrückt + 6-fach diamantiert  
Curb chains - super flat hammered + 6-sides diamond cut  
Chaînes gourmette - super-plates pressées + 6-fois diamantées

SI 12/SF/D6	ca. 31,0 gr/m
SI 14/SF/D6	ca. 35,7 gr/m
SI 16/SF/D6	ca. 57,2 gr/m
SI 18/SF/D6	ca. 71,1 gr/m
SI 22/SF/D6	ca. 97,1 gr/m

Panzerketten - flach und gedreht  
Curb chains - flat and twisted  
Chaînes gourmette - plates et cordelées

SI 025/G	ca. 1,8 gr/m
SI 06/GG	ca. 30 gr/m
SI 08/GG	ca. 35,5 gr/m

Panzerketten - flach und gedreht  
Curb chains - flat and twisted  
Chaînes gourmette - plates et cordelées

SI 05/OV	ca. 11 gr/m
SI 06/9/0	ca. 10,7 gr/m
SI 07/9/0	ca. 14,6 gr/m
SI 08/9/0/B	ca. 20,6 gr/m
SI 10/9/0/B	ca. 31,3 gr/m
SI 12/9/0/B	ca. 45 gr/m
SI 17/G/OV	ca. 89,5 gr/m
SI 25/G/OV	ca. 169 gr/m
SI 30/G/OV	ca. 230 gr/m
SI 35/G/OV	ca. 325 gr/m
SI 40/G/OV	ca. 435 gr/m

Panzerkette - mit Kugeln  
Curb chain - with balls  
Chaîne gourmette - avec boules

SI 03/KU	ca. 5,8 gr/m
----------	--------------

# Panzerketten / Curb chains / Chaînes gourmette

Panzerketten - oval geschliffen  
Curb chains - oval cut  
Chaînes gourmette - limées ovales

SI 08/1/OV ca. 19,5 gr/m

SI 10/1/OV ca. 32,0 gr/m

SI 12/1/OV ca. 44,8 gr/m

SI 13/1/OV ca. 53,4 gr/m

SI 15/1/OV ca. 67,0 gr/m

SI 17/1/OV ca. 85,8 gr/m

SI 18/1/OV ca. 107,3 gr/m

SI 20/1/OV ca. 120,9 gr/m

SI 25/1/OV ca. 197,9 gr/m

SI 30/1/OV ca. 280,5 gr/m

SI 35/1/OV ca. 386,2 gr/m

Panzerketten - ziseliert  
Curb chains - engraved  
Chaînes gourmette - gravées

SI 000460 ca. 32,0 gr/m

SI 15/LI/Z3 ca. 58,3 gr/m

SI 25/LI/Z3 ca. 160,0 gr/m

Panzerketten - rund gedrückt  
Curb chains - round hammered  
Chaînes gourmette - rondes pressées

SI 06/RG ca. 10,5 gr/m

SI 10/RG ca. 29,7 gr/m

Panzer - rhombo-gedrückt, oval geschliffen  
Curb chains - rhomb-hammered, oval cut  
Chaînes gourmette - pressées-rhomb, limées ovales

SI 08/RHG/OV ca. 17,5 gr/m

Panzerketten - aus halbrundem Draht  
Curb chains - made of half-round wire  
Chaînes gourmette - de fil métallique semi-circulaire

SI 12/HR/11D ca. 44,4 gr/m

SI 15/HR/11D ca. 55,4 gr/m

SI 15/HR ca. 67,4 gr/m

Sonstige Panzerketten  
Other curb chains  
Autres chaînes gourmette

SI 000483 ca. 35,0 gr/m

SI 000484 ca. 34,0 gr/m

SI 000485 ca. 39,3 gr/m

SI 000486 ca. 39,4 gr/m

SI 10/LR ca. 33,1 gr/m

SI 20/LR ca. 105,6 gr/m

SI 15/LI/G/OV ca. 57,7 gr/m

SI 15/7 ca. 67,3 gr/m



# Langpanzer / Long Curb / Gourmette espacées

Langpanzerketten - rund  
 Long curb chains - round  
 Chaînes gourmette espacées - rondes

SI 06/2 ca. 8,8 gr/m

SI 07/2 ca. 11,0 gr/m

SI 12/2 ca. 37,2 gr/m

SI 13/2 ca. 43,6 gr/m

SI 20/2 ca. 102,4 gr/m

SI 25/2 ca. 170,1 gr/m

SI 30/2 ca. 248,3 gr/m

SI 05/2/W ca. 5,7 gr/m

SI 06/2/A/LA ca. 10,0 gr/m

SI 07/2/L ca. 11,5 gr/m

SI 10/2/L ca. 22,9 gr/m

SI 15/2/L ca. 52,0 gr/m

SI 20/2/L ca. 92,1 gr/m

SI 23/2/L ca. 125,1 gr/m

SI 23/2/W ca. 100,0 gr/m

Langpanzerketten - diamantiert  
 Long curb chains - diamond cut  
 Chaînes gourmette espacées - diamantées

SI 05/2/A/D ca. 4,5 gr/m

SI 06/2/D ca. 7,9 gr/m

SI 06/2/1/D ca. 8,0 gr/m

SI 07/2/A/D ca. 9,6 gr/m

SI 10/2/A/D ca. 19,8 gr/m

SI 13/2/D ca. 38,6 gr/m

SI 15/2/L/D ca. 44,3 gr/m

SI 20/2/1/D ca. 85,0 gr/m

SI 30/2/D ca. 217,7 gr/m

SI 40/2/B/D ca. 365,0 gr/m

Langpanzerketten - 4-fach diamantiert  
 Long curb chains - 4-sides diamond cut  
 Chaînes gourmette espacées-4 fois diamantées

SI 12/2/11/D ca. 41,0 gr/m

SI 13/2/D4 ca. 33,2 gr/m

SI 15/2/L/D4 ca. 40,5 gr/m

# Langpanzer / Long Curb / Gourmette espacées

Langpanzerketten - gedrückt  
 Long curb chains - hammered  
 Chaînes gourmette espacées - pressées

SI 05/2/A/G ca. 5 gr/m

SI 07/2/A/G ca. 10,2 gr/m

SI 10/2/A/G ca. 21,5 gr/m

SI 13/2/G ca. 39,3 gr/m

SI 15/2/LG ca. 46,8 gr/m

SI 25/LG ca. 150 gr/m

SI 17/2/LG ca. 68,5 gr/m

SI 23/2/LG ca. 132,5 gr/m

Langpanzerketten - geschliffen  
 Long curb chains - cut  
 Chaînes gourmette espacées - limées

SI 17/LG/1 ca. 63,8 gr/m

SI 30/LG/1 ca. 190 gr/m

Langpanzerketten - oval geschliffen  
 Long curb chains - oval cut  
 Chaînes gourmette espacées - limées ovales

SI 10/2/A/OV ca. 19,2 gr/m

SI 13/2/OV ca. 34,1 gr/m

SI 15/2/L/OV ca. 35,1 gr/m

Langpanzerkette - aus ovalem Draht  
 Long curb chain - made of oval wire  
 Gourmette espacée - de fil métallique ovale

SI 18/2/WHR ca. 75 gr/m

Langpanzerketten - ziseliert  
 Long curb chains - engraved  
 Chaînes gourmette espacées - gravées

SI 000429/Z3 ca. 14,3 gr/m

SI 000459 ca. 25,3 gr/m

SI 12/3/Z ca. 35,5 gr/m

SI 15/2/SSL/Z3 ca. 36,8 gr/m

SI 17/3/Z ca. 68,8 gr/m

SI 20/3/Z ca. 99,5 gr/m

SI 23/2/L/Z3 ca. 84,8 gr/m

SI 23/2/WZ3 ca. 100 gr/m

SI 25/3/Z ca. 162,9 gr/m

## Doppelpanzer / Double curb / Gourmette double

Doppelpanzerketten - rund  
Double curb chains - round  
Chaînes gourmette double - rondes

SI 045/37 ca. 11,3 gr/m

SI 06/37 ca. 19,9 gr/m

SI 08/37 ca. 35,2 gr/m

SI 12/37 ca. 90,0 gr/m

SI 25/37 ca. 400,0 gr/m

Doppelpanzerketten - weit, geschliffen  
Double curb chains - wide, cut  
Chaînes gourmette double - étendues, limées

SI 06/37/W/1 ca. 16,1 gr/m

SI 08/37/W/1 ca. 29,4 gr/m

SI 18/37/WA/1 ca. 148,5 gr/m

Doppelpanzerketten - oval geschliffen  
Double curb chains - oval cut  
Chaînes gourmette double - limées ovales

SI 12/37/OV ca. 74,0 gr/m

SI 18/37/WOV ca. 165,0 gr/m

SI 25/37/1/OV ca. 380,0 gr/m

Doppelpanzerketten - weit  
Double curb chains - wide  
Chaînes gourmette double - étendues

SI 06/37/W ca. 17,7 gr/m

SI 08/37/W ca. 32,3 gr/m

SI 10/37/W ca. 52,0 gr/m

SI 18/37/W ca. 178,5 gr/m

SI 18/37/WA ca. 154,0 gr/m

SI 20/37/W ca. 202,4 gr/m

Doppelpanzerketten - gedreht  
Double curb chains - twisted  
Chaînes gourmette double - cordelées

SI 045/77 ca. 10,0 gr/m

SI 06/77 ca. 14,5 gr/m

SI 08/77 ca. 27,1 gr/m

SI 10/77 ca. 37,9 gr/m

SI 12/77 ca. 59,0 gr/m

## Deutschpanzer/ German curb / Gourmette allemande

Deutschpanzerketten - rund  
German curb chains - round  
Chaînes gourmette allemande - rondes

SI 10/DP ca. 61 gr/m

SI 13/DP ca. 108,1 gr/m

Deutschpanzerketten - oval geschliffen  
German curb chains - oval cut  
Chaînes gourmette allemande-limées ovales

SI 10/DPOV ca. 61,4 gr/m

SI 13/DPOV ca. 102 gr/m

## Steg-Panzer / Bar curb / Gourmette marine

Stegpanzerketten - diamantiert  
Bar curb chains - diamond cut  
Chaînes gourmette marine - diamantées

SI 06/STD ca. 9,3 gr/m

SI 07/ST2/D ca. 11,3 gr/m

SI 08/STD ca. 18,1 gr/m

SI 10/ST2/D ca. 24,2 gr/m

SI 10/STD ca. 24,3 gr/m

SI 13/STD ca. 40,2 gr/m

SI 15/ST2/D ca. 49,9 gr/m

Stegpanzerketten - 4 fach diamantiert  
Bar curb chains - 4-sides diamond cut  
Gourmette marine - 4 fois diamantées

SI 10/ST2/D4 ca. 22,4 gr/m

SI 13/STD4 ca. 39,1 gr/m

SI 15/ST2/D4 ca. 50,2 gr/m

Stegpanzerkette - flach  
Bar curb chain - flat  
Chaîne gourmette marine - plate

SI 12/ST/FG ca. 30 gr/m

Stegpanzerkette - gedrückt  
Bar curb chain - hammered  
Chaîne gourmette marine - pressée

SI 13/STG ca. 44,4 gr/m

Stegpanzerketten - oval geschliffen  
Bar curb chains - oval cut  
Chaînes gourmette marine - limées ovales

SI 13/STOV ca. 37,5 gr/m

SI 15/STOV ca. 54,9 gr/m

SI 20/STOV ca. 107,3 gr/m

Stegpanzerketten - rund  
Bar curb chains - round  
Gourmette marine - rondes

SI 06/ST ca. 9,8 gr/m

24

Basic-Classic-Collection

## Steg-Langpanzer / Long bar curb chains / Gourmette marine espacées

Steg-Langpanzerketten - diamantiert  
Long bar curb chains - diamond cut  
Gourmette marine espacées - diamantées

SI 10/STD/L ca. 22,4 gr/m

SI 15/STD/L ca. 49,4 gr/m

Steg-Langpanzerketten - 4 fach diamantiert  
Long bar curb chains - 4-sides diamond cut  
Gourmette marine espacées-4 fois diamantées

SI 10/STD4/L ca. 19,4 gr/m

SI 15/STD4/L ca. 46,6 gr/m

Steg-Langpanzerketten - gedrückt  
Long bar curb chains - hammered  
Gourmette marine espacées - pressées

SI 05/STG/L ca. 5,5 gr/m

SI 07/STG/L ca. 11,4 gr/m

SI 10/STG/L ca. 23,4 gr/m

SI 15/STG/L ca. 51,6 gr/m

# Figaro-Panzer / Figaro Curb / Figaro gourmette

Figaro-Panzerketten - diamantiert  
 Figaro curb chains - diamond cut  
 Chaînes figaro gourmette - diamantées

SI 04/FI/1/D ca. 3,9 gr/m

SI 06/FI/0D ca. 8,3 gr/m

SI 06/FI/1/D ca. 9,7 gr/m

SI 08/FI/1/D ca. 15,9 gr/m

SI 10/FI/1/D ca. 25,4 gr/m

SI 10/FI/2/LD ca. 22,0 gr/m

SI 10/FI/6D ca. 24,9 gr/m

SI 12/FI/2/LD ca. 30,0 gr/m

SI 15/FI/1/D ca. 56,6 gr/m

SI 15/FI/2/LD ca. 46,0 gr/m

SI 15/FI/E1/D ca. 60,8 gr/m

SI 15/FI/E6D ca. 64,9 gr/m

SI 18/FI/1/D ca. 83,2 gr/m

SI 18/FI/2/LD ca. 70,0 gr/m

SI 20/FI/2/LD ca. 87,0 gr/m

Figaro-Panzerketten - 4-fach diamantiert  
 Figaro curb chains - 4-sides diamond cut  
 Chaînes figaro gourmette - 4 fois diamantées

SI 10/FI/1/LD4 ca. 20,0 gr/m

SI 12/FI/1/LD4 ca. 28,5 gr/m

SI 15/FI/1/LD4 ca. 46,9 gr/m

SI 20/FI/1/LD4 ca. 81,3 gr/m

Figaro-Panzerketten - flach gedrückt / diamantiert  
 Figaro curb chains - flat hammered / diamond cut  
 Gourmettes figaro - plates pressées / diamantées

SI 15/FIF/14 ca. 44,8 gr/m

SI 15/FIF/04 ca. 46,0 gr/m

SI 18/FIF/14 ca. 73,1 gr/m

SI 18/FIF/04 ca. 63,2 gr/m

SI 20/FIF/14 ca. 89,9 gr/m

SI 20/FIF/04 ca. 79,5 gr/m

SI 12/FI/1/D/FL ca. 27,0 gr/m

SI 12/FIF/0D ca. 31,8 gr/m

SI 15/FIF/1D ca. 55,5 gr/m

SI 15/FIF/0D ca. 49,0 gr/m

SI 18/FIF/1D ca. 76,1 gr/m

SI 18/FIF/0D ca. 68,0 gr/m

SI 20/FIF/1D ca. 96,7 gr/m

SI 23/FIF/1D ca. 128,0 gr/m

# Figaro-Panzer / Figaro Curb / Figaro gourmette

Figaro-Panzerketten - rund  
 Figaro curb chains - round  
 Chaînes figaro gourmette - rondes

SI 04/FI/1 ca. 4,1 gr/m

SI 04/FI/6 ca. 4,2 gr/m

SI 05/FI/1 ca. 6,4 gr/m

SI 06/FI/1 ca. 10 gr/m

SI 06/FI/0 ca. 9,5 gr/m

SI 06/FI/11 ca. 9,7 gr/m

SI 06/FI/153 ca. 10,8 gr/m

SI 06/FI/21 ca. 10,4 gr/m

SI 08/FI/1 ca. 17,4 gr/m

SI 08/FI/11 ca. 17,2 gr/m

SI 08/FI/21 ca. 18,1 gr/m

SI 08/FI/153 ca. 18,5 gr/m

SI 10/FI/11 ca. 24,5 gr/m

SI 10/FI/21 ca. 26,3 gr/m

SI 10/FI/153 ca. 28 gr/m

SI 12/FI/1 ca. 40,7 gr/m

SI 15/FI/0 ca. 60,3 gr/m

SI 15/FI/1 ca. 64,3 gr/m

SI 15/FI/11 ca. 56,2 gr/m

SI 15/FI/11/A ca. 68,5 gr/m

SI 23/FI/1 ca. 154,6 gr/m

Figaro-Panzerketten - oval geschliffen  
 Figaro curb chains - oval cut  
 Chaînes figaro gourmette - limées ovales

SI 10/FI/1/OV ca. 24,5 gr/m

SI 12/FI/1/OV ca. 36,8 gr/m

SI 12/FI/5/OV ca. 37,2 gr/m

SI 15/FI/0/OV ca. 55,2 gr/m

SI 15/FI/1/OV ca. 63,7 gr/m

SI 15/FI/10/OV ca. 51 gr/m

SI 18/FI/1/OV ca. 88 gr/m

SI 06/FI/5/OV ca. 11 gr/m

SI 08/FI/5/OV ca. 16 gr/m

SI 10/FI/5/OV ca. 24,5 gr/m

SI 15/FI/5/OV ca. 70 gr/m

SI 18/FI/5/OV ca. 90 gr/m

SI 23/FI/5/OV ca. 160 gr/m

## S-Panzerketten / S-Curb chains / Chemin de fer

S-Panzerketten - rund  
S-Curb chains - round  
Chaînes chemin de fer - rondes

SI 04/33	ca. 7 gr/m
SI 05/33	ca. 11,3 gr/m
SI 06/33	ca. 16,4 gr/m
SI 08/33	ca. 28,9 gr/m
SI 10/33	ca. 46,6 gr/m
SI 12/33	ca. 71,1 gr/m

S-Panzerketten - rund gedrückt  
S-Curb chains - round hammered  
Chaînes chemin de fer - rondes pressées

SI 06/33/R	ca. 16,5 gr/m
SI 08/33/R	ca. 27,9 gr/m

S-Panzerkette - gedrückt  
S-Curb chain - hammered  
Chaîne chemin de fer - pressée

SI 08/33/LG	ca. 26,8 gr/m
-------------	---------------

S-Panzerkette - hohl gedrückt  
S-Curb chain - hollow hammered  
Chaîne chemin de fer - creuse pressée

SI 06/33/H	ca. 15,5 gr/m
------------	---------------

S-Panzerketten - diamantiert  
S-Curb chains - diamond cut  
Chaînes chemin de fer - diamantées

SI 04/33/D	ca. 6,5 gr/m
SI 05/33/D	ca. 10,5 gr/m
SI 06/33/D	ca. 14,5 gr/m
SI 07/33/D	ca. 20,5 gr/m
SI 08/33/D	ca. 28,2 gr/m
SI 10/33/D	ca. 43,1 gr/m
SI 12/33/D	ca. 63,9 gr/m

SI 23/33/D ca. 230,4 gr/m

S-Panzerketten - oval gedrückt  
S-Curb chains - oval hammered  
Chaînes chemin de fer - pressées ovales

SI 08/33/OV	ca. 26,3 gr/m
SI 10/33/OV	ca. 42 gr/m
SI 12/33/OV	ca. 62,2 gr/m
SI 15/33/OV	ca. 90,7 gr/m
SI 18/33/OV	ca. 1310 gr/m
SI 23/33/OV	ca. 200 gr/m

## Zwillings--Panzer / Twin curb / Gourmette jumelle

SI 05/39	ca. 14,3 gr/m
SI 07/39	ca. 28,1 gr/m
SI 10/39	ca. 60,9 gr/m



# Erbsketten / Belcher chains / Chaînes jaseron

Erbsketten - rund  
Belcher chains - round  
Chaînes jaseron - rondes

SI 0	ca. 11,6 gr/m
SI 0/1	ca. 7,0 gr/m
SI 0/2	ca. 12,7 gr/m
SI 0/3	ca. 19,0 gr/m
SI 0/4	ca. 10,6 gr/m
SI 0/5	ca. 24,0 gr/m
SI 1	ca. 31,2 gr/m
SI 1/B	ca. 24,2 gr/m
SI 2	ca. 41,8 gr/m
SI 2/1	ca. 35,6 gr/m
SI 2/2	ca. 25,0 gr/m
SI 2/3	ca. 22,9 gr/m
SI 3	ca. 65,8 gr/m
SI 3/1B	ca. 30,5 gr/m
SI 3/B	ca. 52,2 gr/m
SI 4/B	ca. 100,0 gr/m
SI 5	ca. 142,4 gr/m
SI 18/0	ca. 188,4 gr/m
SI 18/0/A	ca. 148,6 gr/m
SI 18/X	ca. 218,1 gr/m
SI 18/XA	ca. 323 gr/m
SI 18/XA/A	ca. 211,5 gr/m

Erbsketten - rund weit  
Belcher chains - round, wide  
Chaînes jaseron - rondes étendues

SI 0/2/W	ca. 6,2 gr/m
SI 0/2/W/A	ca. 8,9gr/m
SI 0/6	ca. 20,0 gr/m
SI 18/Y/L	ca. 247,0 gr/m

Erbsketten - oval  
Belcher chains - oval  
Chaînes jaseron - ovales

SI 000427	ca. 19,8 gr/m
SI 000427/A	ca. 13,3 gr/m
SI 000495	ca. 20,0 gr/m
SI 0/1/OV	ca. 6,3 gr/m
SI 0/2/OV	ca. 8,7 gr/m
SI 1/OV	ca. 21,0 gr/m
SI 2/OV	ca. 35,0 gr/m
SI 3/OV	ca. 75,0 gr/m
SI 5/OV	ca. 105,0 gr/m
SI 18/0/OV	ca. 147,1 gr/m

Sonstige Erbsketten  
Other belcher chains  
Autres chaînes jaseron

SI 000907	ca. 7,0 gr/m
-----------	--------------



# Erbsketten / Belcher chains / Chaînes jaseron

Erbsketten - hohl / rund  
 Belcher chains - hollow / round  
 Chaînes jaseron - creuses / rondes

SI E5,5/H ca. 53,0 gr/m

SI E6/H ca. 75,0 gr/m

SI E7/H ca. 70,0 gr/m

SI E8/H ca. 78,0 gr/m

SI E8,5/H ca. 115,0 gr/m

SI E10/H ca. 140,3 gr/m

SI E12/H ca. 225,0 gr/m

SI E13/H ca. 260,0 gr/m

SI E15/H ca. 350,0 gr/m

SI E8/H/P3 ca. 72,2 gr/m

SI E10/H/P1 ca. 104,6 gr/m

SI E10/H/P2 ca. 113,7 gr/m

SI E10/H/P3 ca. 126,4 gr/m

SI E13/H/P1 ca. 225,6 gr/m

Erbsketten - hohl / rund  
 Belcher chains - hollow / round  
 Chaînes jaseron - creuses / rondes

SI E13/H/P2 ca. 238,7 gr/m

SI 000655 ca. 162,8 gr/m

Erbskette - oval, weit  
 Belcher chain - oval, wide  
 Chaîne jaseron - ovale, étendue

SI 3/OV/W ca. 43,2 gr/m

SI 5/OV/W ca. 63,3 gr/m

SI 18/100 ca. 125,0 gr/m

Erbsketten - oval, weit, ziseliert  
 Belcher chains - oval, wide, engraved  
 Chaînes jaseron - ovale, étendue, gravées

SI 3/OV/WZ3 ca. 37,4 gr/m

SI 5/OV/WZ3 ca. 48,0 gr/m

Erbsketten - ziseliert  
 Belcher chains - engraved  
 Chaînes jaseron - gravées

SI 4/AZ/B ca. 110,4 gr/m

SI 18/3/KZ ca. 212,2 gr/m

SI 18/XA/ZB ca. 223,5 gr/m

Erbsketten - hohl / ziseliert  
 Belcher chains - hollow / engraved  
 Chaînes jaseron - creuses / gravées

SI 000656 ca. 112,8 gr/m



## Kugelnketten / Ball chains / Chaînes boules

Kugelnketten - rund Ball chains - round Chaînes boules - rondes	
SI 10/KU	ca. 2,9 gr/m
SI 12/KU	ca. 4,3 gr/m
SI 15/KU	ca. 6,6 gr/m
SI 20/KU	ca. 11,6 gr/m
SI 25/KU	ca. 17,4 gr/m
SI 32/KU	ca. 23 gr/m
SI 45/KU	ca. 52,5 gr/m
Kugelnketten - diamantiert Ball chains - diamond cut Chaînes boules - diamantées	
SI 10/KU/D	ca. 2,5 gr/m
SI 12/KU/D	ca. 3,7 gr/m
Kugelnketten-Variation - rund Ball chain variation - round Variation de chaîne-boules - rondes	
SI 10/KUA/1	ca. 2,75 gr/m
SI 15/KU/LK	ca. 7,8 gr/m
SI 15/TO	ca. 7,8 gr/m
SI 25/KU/LK	ca. 20,5 gr/m
SI 28/LI	ca. 23 gr/m

Kugelnketten-Variation - glänzend Ball chain variation - shiny Variation de chaîne-boules - brillantes	
SI 20-4231	ca. 12,54 gr/m
SI 25-4231	ca. 20,1 gr/m
SI 30-4231	ca. 25,3 gr/m
SI 40-4231	ca. 43,6 gr/m
Kugelnketten-Variation - matt/glänzend Ball chain variation - matt/shiny Variation de chaîne-boules - mates/brillantes	
SI 25/KU/LK/MG	ca. 20,5 gr/m
SI 25-4231/MG	ca. 20,1 gr/m
SI 30-4231/MG	ca. 25,3 gr/m
SI 40-4231/MG	ca. 43,6 gr/m
SI 45/KU/MG	ca. 52,6 gr/m
SI 40/KU/OLV/MG	ca. 41,4 gr/m
Kugelnketten - mehrreihig Ball chains - multi-row Chaînes boules - avec plusieurs rangs	
SI 15/KU/4R	ca. 24,9 gr/m

## Olivketten / Olive chains / Chaînes olive

SI 23/KU/OLV	ca. 15,2 gr/m
SI 30/KU/OLV	ca. 23,2 gr/m

SI 40/KU/OLV	ca. 42,6 gr/m
--------------	---------------

## Walzenketten / Roll chains / Chaînes cylindre

SI 15/WA	ca. 7,9 gr/m
SI 20/WA	ca. 11,7 gr/m
SI 23/WA	ca. 16,5 gr/m

# Schlangenketten / Snake chains / Chaînes serpent

Schlangenketten - rund  
Snake chains - round  
Chaînes serpent - rondes

SI 09-0155 ca. 6,0 gr/m

SI 10-0155 ca. 8,2 gr/m

SI 12-0155 ca. 10 gr/m

SI 16-0155 ca. 17,7 gr/m

SI 18-0155 ca. 24,1 gr/m

SI 30-0155 ca. 55,6 gr/m

Schlangenketten - 4-fach diamantiert  
Snake chains - 4-sides diamond cut  
Chaînes serpent - 4 fois diamantées

SI 10-0155/4D ca. 9,5 gr/m

SI 12-0155/4D ca. 12,0 gr/m

Schlangenketten - 8-fach diamantiert  
Snake chains - 8-sides diamond cut  
Chaînes serpent - 8 fois diamantées

SI 09-0155/8D ca. 5,0 gr/m

SI 10-0155/8D ca. 6,3 gr/m

SI 12-0155/8D ca. 9,3 gr/m

Schlangenketten - spezial diamantiert  
Snake chains - special diamond cut  
Chaînes serpent - spéciale diamantées

SI 12-0155/SPD ca. 12,0 gr/m

SI 14-0155/SPD ca. 13,9 gr/m

SI 16-0155/SPD ca. 15,8 gr/m

SI 30-0155/SPD ca. 52,1 gr/m

Schlangenketten - diamantiert + gedreht  
Snake chains - diamond cut + twisted  
Chaînes serpent - diamantées + cordelées

SI 16-0155/GD ca. 10,0 gr/m

Schlangenketten - rund mit Kugeln  
Snake chains - round with balls  
chaînes serpent - rondes avec boules

SI 12-0155/KU ca. 12,3 gr/m

SI 12-0155/2KU ca. 26,2 gr/m

SI 12-0155/3KU ca. 30,8 gr/m

SI 12-0155/31KU ca. 26,0 gr/m

SI 16-0155/KU ca. 30,4 gr/m

SI 16-0155/2KU ca. 26,2 gr/m

SI 16-0155/3KU ca. 30,8 gr/m

SI 16-0155/31KU ca. 26,0 gr/m

SI 19-0155/KU ca. 30,4 gr/m

Echte Schlangenketten - rund  
Real snake chains - round  
Chaînes vrai serpent - rondes

SI 16/SK ca. 12,7 gr/m

SI 19/SK ca. 14,5 gr/m

SI 24/SK ca. 21,2 gr/m

SI 32/SK ca. 30,7 gr/m

SI 42/SK ca. 52 gr/m

SI 50/SK ca. 58 gr/m

## Gansgurgelkette / Goose neck chain / Chaîne gorge d'oie



## Rollokette / Roller chain / Chaîne store



## Pantherketten / Panther chains / Chaînes «Panthère»



36

## Himbeerketten / Popcorn chains / Chaînes «framboise»

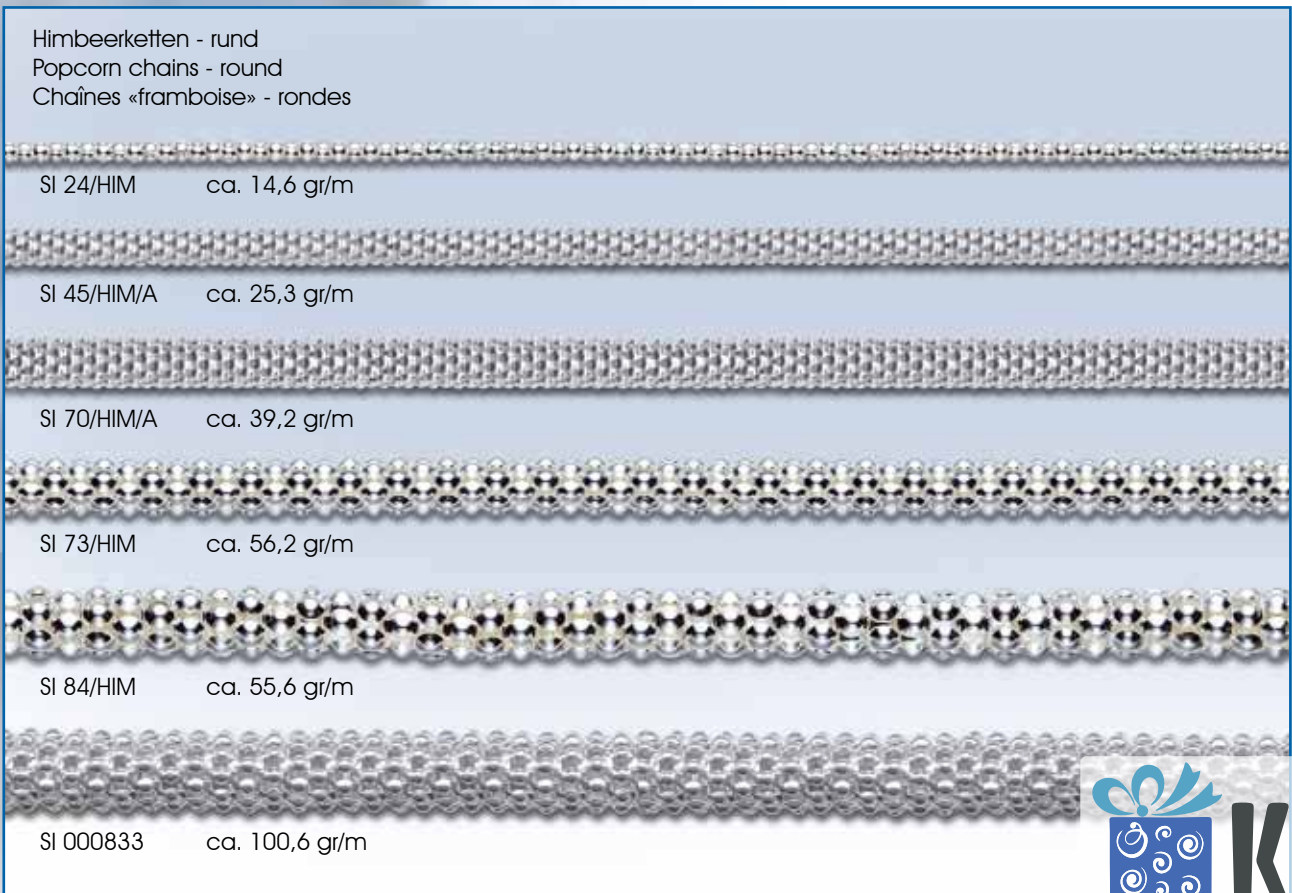

Lambada-Armbänder flexibel / Lambada bracelets flexible /  
Lambada bracelets élastiques

37

Basic-Classic-Collection



SI AR 70/HIM/A 10,5 gr



SI AR 45/HIM/A 6,5 gr



SI AR 000787 21,7 gr



SI AR 000788 15,0 gr



SI AR 000805 12,0 gr



SI AR 000853 10,9 gr

# Königsketten / Royal chains / Chaînes royales

Königsketten - rund  
Royal chains - round  
Chaînes royales - rondes



SI 08/KO ca. 72 gr/m



SI 10/KO ca. 120 gr/m



SI 12/KO ca. 170 gr/m



SI 15/KO ca. 230 gr/m



SI 18/KO ca. 365,6 gr/m



SI 06/KO/R ca. 27 gr/m



SI 08/KO/R ca. 52 gr/m



SI 10/KO/R ca. 79 gr/m



SI 12/KO/R ca. 170 gr/m



SI 15/KO/R ca. 181 gr/m

Königsketten - oval gedrückt  
Royal chains - oval hammered  
Chaînes royales - pressées ovales



SI 08/KO/OV ca. 62 gr/m



SI 10/KO/OV ca. 100 gr/m



SI 12/KO/OV ca. 135 gr/m



SI 15/KO/OV ca. 215 gr/m

Königsketten - 4-fach diamantiert  
Royal chains - 4-sides diamond cut  
Chaînes royales - 4 fois diamantées



SI 06/KO/1/1D ca. 31 gr/m



SI 08/KO/1/1D ca. 57 gr/m



SI 10/KO/1/1D ca. 87 gr/m



SI 12/KO/1/1D ca. 135 gr/m



SI 15/KO/1/1D ca. 197 gr/m



SI 18/KO/1/1D ca. 310 gr/m



SI 20/KO/1/1D ca. 330 gr/m

Königsketten - 8-fach diamantiert  
Royal chains - 8-sides diamond cut  
Chaînes royales - 8 fois diamantées



SI 06/KO/D8 ca. 30 gr/m



SI 08/KO/D8 ca. 52 gr/m



SI 10/KO/D8 ca. 82 gr/m



SI 12/KO/D8 ca. 119 gr/m



SI 15/KO/D8 ca. 178,2 gr/m

Königsketten - 4-seitig geschliffen  
Royal chains - cut on all four sides  
Chaînes royales - limées de 4 côtés



SI 08/KO/4 ca. 55,4 gr/m

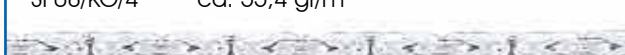

SI 10/KO/4 ca. 90,8 gr/m

## Etruskerketten / Etruscan chains / Chaînes étrusques

Etruskerketten - rund  
Etruscan chains - round  
Chaînes étrusques - rondes



SI 000512	ca. 190 gr/m
SI 000513	ca. 320 gr/m

Etruskerketten - diamantiert  
Etruscan chains - diamond cut  
Chaînes étrusques - diamantées



SI 000512/D	ca. 135 gr/m
SI 000513/D	ca. 265 gr/m

## Kordelketten / Rope chains / Chaînes corde

Kordelketten - geschliffen  
Rope chains - cut  
Chaînes corde - limée



SI 000554	ca. 11 gr/m
SI 000555	ca. 26,5 gr/m
SI 000556	ca. 45,2 gr/m
SI 000557	ca. 66,7 gr/m

Kordelketten - diamantiert  
Rope chains - diamond cut  
Chaînes corde - diamantées



SI 000566	ca. 32 gr/m
-----------	-------------

Kordelketten - flach gewalzt  
Rope chains - flattened  
Chaînes corde - aplaties au rouleau



SI 7/8	ca. 18,4 gr/m
SI 7/3	ca. 49,8 gr/m

## Zopfketten / Wheat chains / Chaînes tressées

Zopfketten - rund  
Wheat chains - round  
Chaînes tressées - rondes

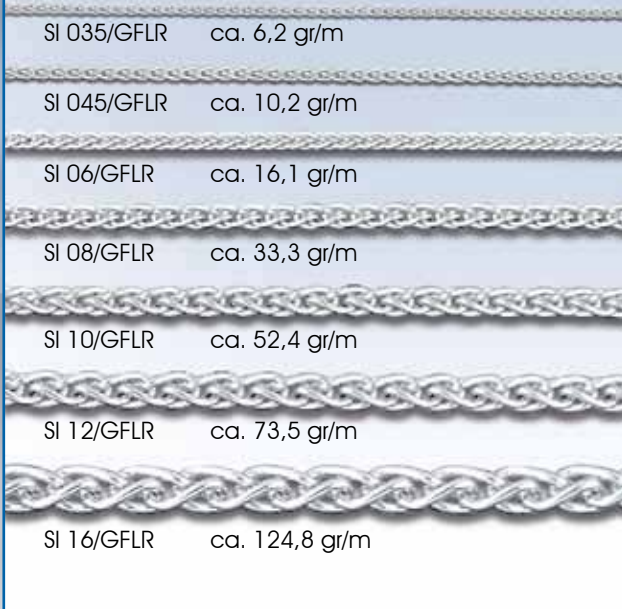

SI 035/GFLR	ca. 6,2 gr/m
SI 045/GFLR	ca. 10,2 gr/m
SI 06/GFLR	ca. 16,1 gr/m
SI 08/GFLR	ca. 33,3 gr/m
SI 10/GFLR	ca. 52,4 gr/m
SI 12/GFLR	ca. 73,5 gr/m
SI 16/GFLR	ca. 124,8 gr/m

Zopfketten - oval gedrückt  
Wheat chains - oval hammered  
Chaînes tressées - pressées ovales

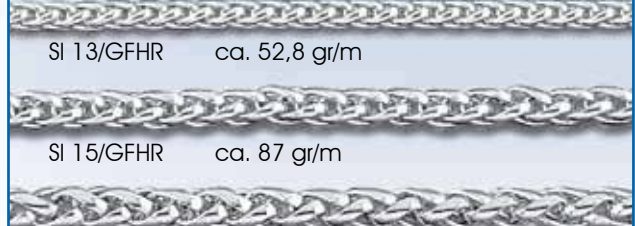

SI 13/GFHR	ca. 52,8 gr/m
SI 15/GFHR	ca. 87 gr/m
SI 20/GFHR	ca. 116,2 gr/m

Zopfketten - halbrund  
Wheat chains - half-round  
Chaînes tressées - semi-circulaire



SI 10/GFL/OV	ca. 45,5 gr/m
--------------	---------------

## Omegaketten rund / Omega chains round / Chaînes oméga rondes



## Spiralketten rund / Spiral chains round / Chaînes spirales rondes





## Venezianerketten / Venetian chains / Chaînes vénitiennes

Venezianerketten - rund  
Venetian chains - round  
Chaînes vénitiennes - rondes

SI 14/10 ca. 5,9 gr/m

SI 14/12 ca. 7,5 gr/m

SI 14/15 ca. 11,9 gr/m

SI 14/17 ca. 18,6 gr/m

SI 14/19 ca. 18,7 gr/m

SI 14/24 ca. 33,2 gr/m

SI 14/30 ca. 52,3 gr/m

SI 14/50 ca. 127,8 gr/m

SI 14/70 ca. 266 gr/m

Venezianerketten - diamantiert  
Venetian chains - diamond cut  
Chaînes vénitiennes - diamantées

SI 14/10/D ca. 5,1 gr/m

SI 14/12/D ca. 7 gr/m

SI 14/15/D ca. 10 gr/m

SI 14/17/D ca. 17,5 gr/m

SI 14/21/D ca. 64 gr/m

SI 14/24/D ca. 25,6 gr/m

SI 14/30/D ca. 41,7 gr/m

SI 14/50/D ca. 128 gr/m

SI 14/70/D ca. 213 gr/m

Venezianerketten - 8-fach diamantiert  
Venetian chains - 8-sides diamond cut  
Chaînes vénitiennes - 8 fois diamantées

SI 14/12/D8 ca. 6,4 gr/m

SI 14/17/D8 ca. 15,5 gr/m

SI 14/24/D8 ca. 25,9 gr/m

SI 14/50/D8 ca. 116 gr/m

Venezianerketten - oval  
Venetian chains - oval  
Chaînes vénitiennes - ovales

SI 14/9/OV ca. 4,9 gr/m

SI 14/17/OV ca. 11,5 gr/m

SI 14/20/OV ca. 17,5 gr/m

SI 14/21/OV ca. 57,6 gr/m

SI 14/25/OV ca. 26 gr/m

SI 14/30/OV ca. 36,8 gr/m

SI 14/42/OV ca. 72 gr/m

SI 14/55/OV ca. 121,7 gr/m

SI 14/70/OV ca. 242,0 gr/m

Venezianerketten lang  
Venetian chains - long  
Chaînes vénitiennes longues

SI 14/3/L ca. 13,8 gr/m

SI 14/1/L ca. 9 gr/m

## Haferkornketten / Barley corn chains / Chaînes épi

SI 50/HAF ca. 4,7 gr/m

SI 70/HAF ca. 15,9 gr/m

# ID-Bänder / ID straps / Bracelets d'identité

43

Basic-Classic-Collection



SI P1/23 cm ca. 70 gr/23 cm



SI P2/23 cm ca. 70 gr/23 cm



SI P3/21 cm ca. 63,9 gr/21 cm



SI P5/21 cm ca. 40 gr/21 cm



SI P6/21 cm ca. 40 gr/21 cm



SI P7/19 cm ca. 17,1 gr/19 cm



SI P8/19 cm ca. 20,2 gr/19 cm



SI P9/18 cm ca. 1,96 gr/18 cm



SI P10/19 cm ca. 4 gr/19 cm

## Noblesse-Hohlketten/ Hollow chains / Chaînes creuses

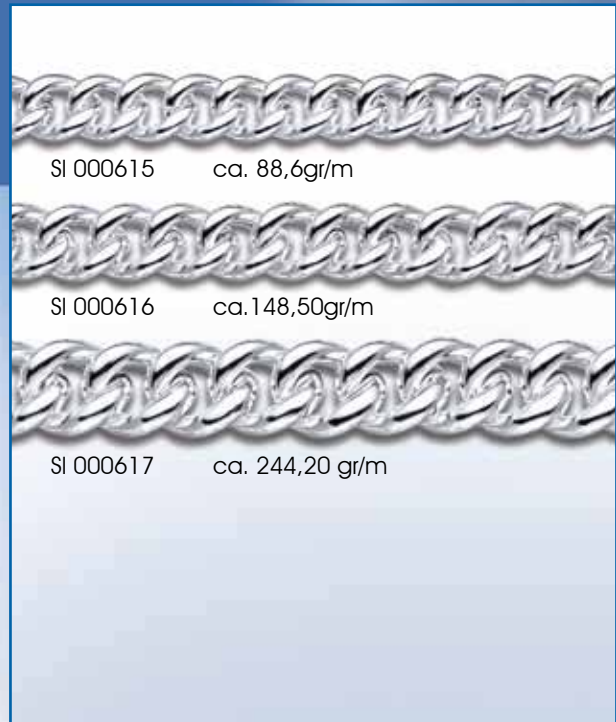
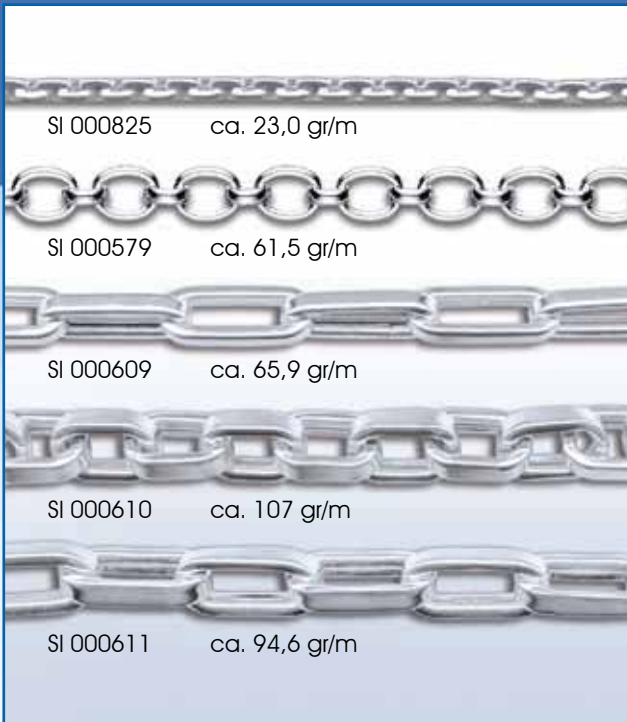

## Kaffeebohnen-Ketten/ Coffee bean chains / Chaînes grain de café

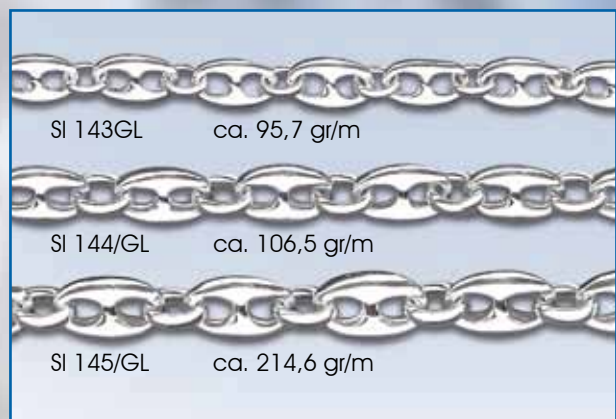
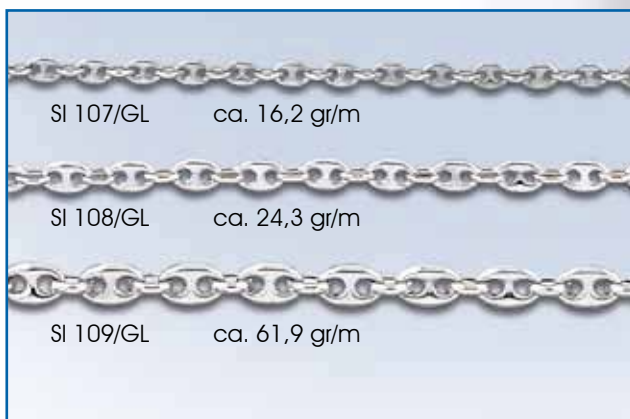

## Herz-Ketten / Heart chains / Chaînes coeurs

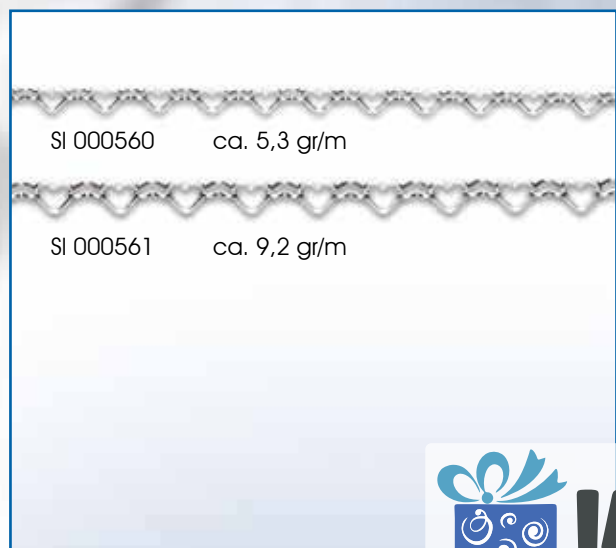
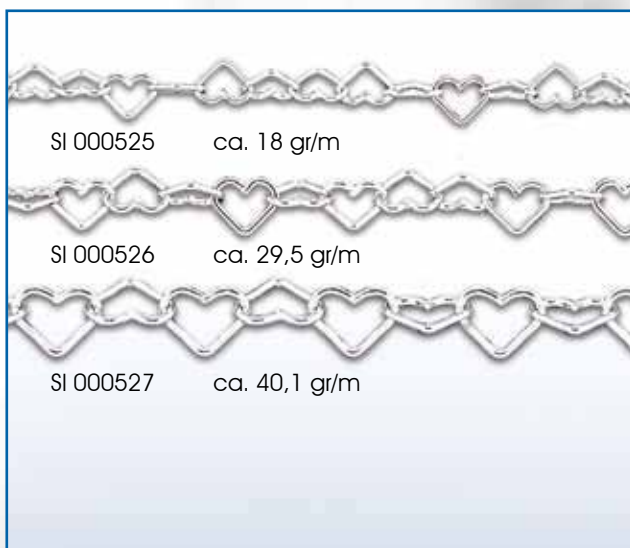

## Garibaldi-Ketten / Garibaldi chains / Chaînes garibaldi

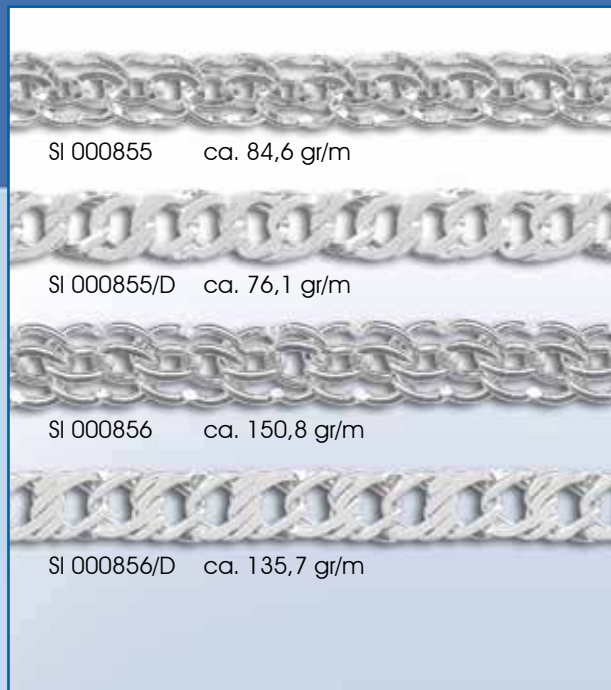
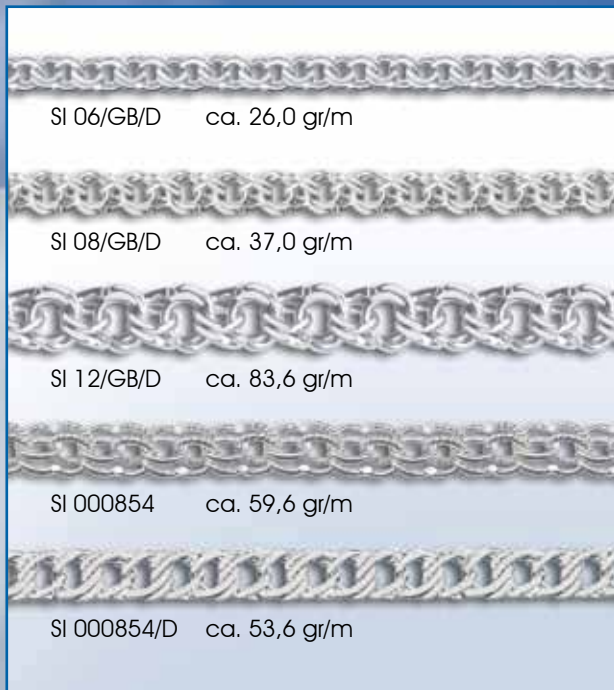

## Prestige-Ketten/ Prestige chains / Chaînes «prestige»

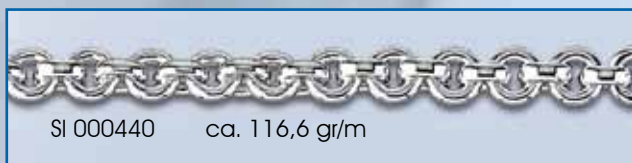

50

## Geflechtketten/ Mesh chains / Chaînes treillis

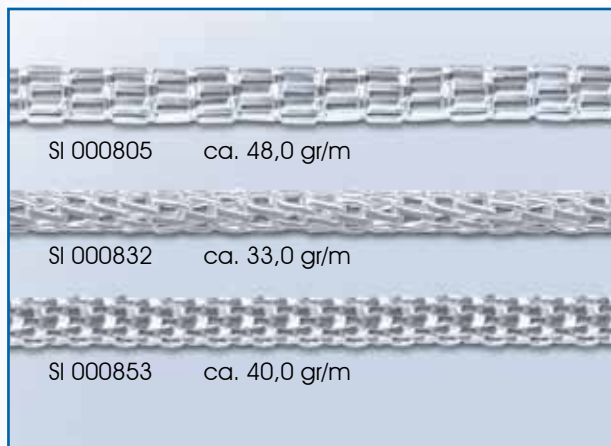
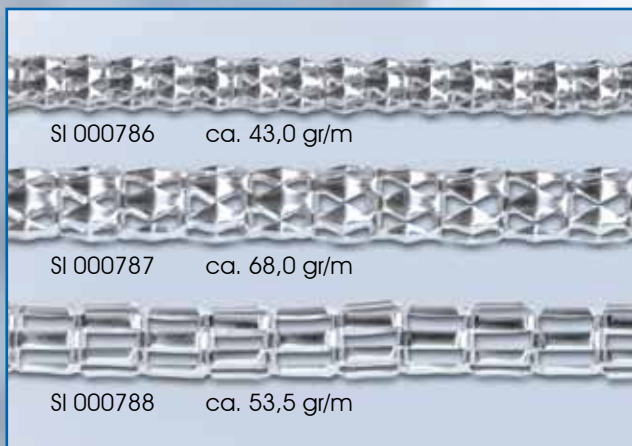

## Popcorn-Ketten / Popcorn chains / Chaînes popcorn

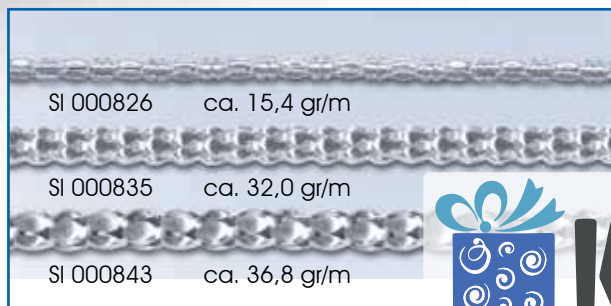

# Calla-Ketten / Calla chains / Chaînes « calla »

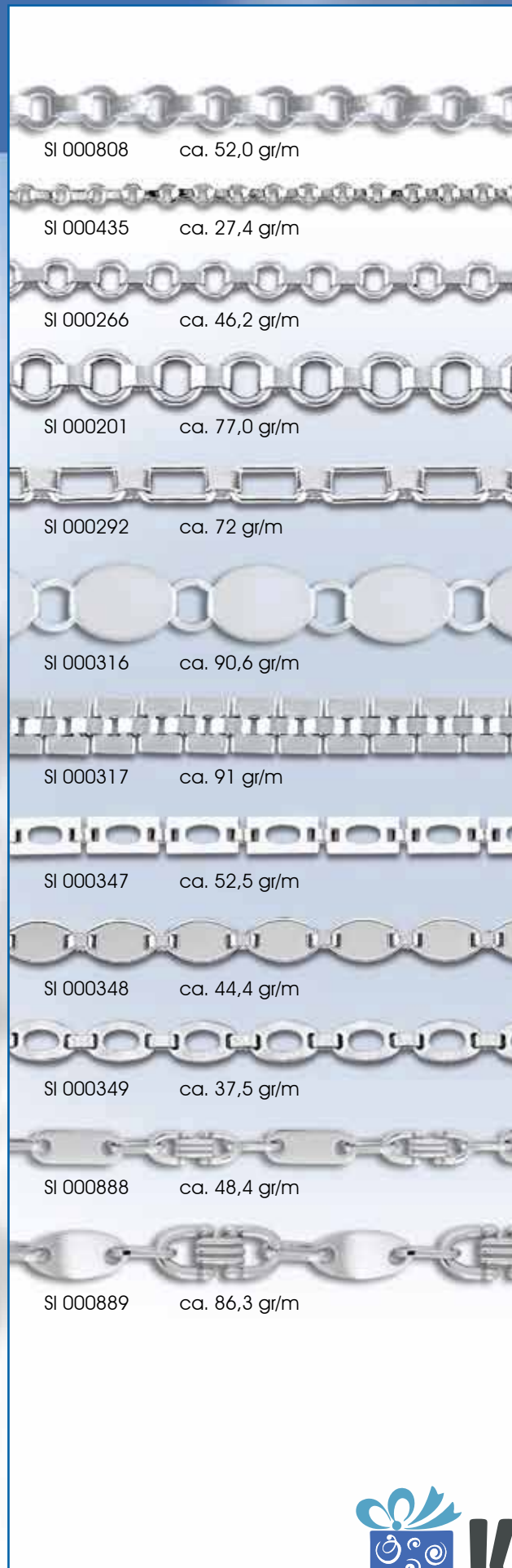
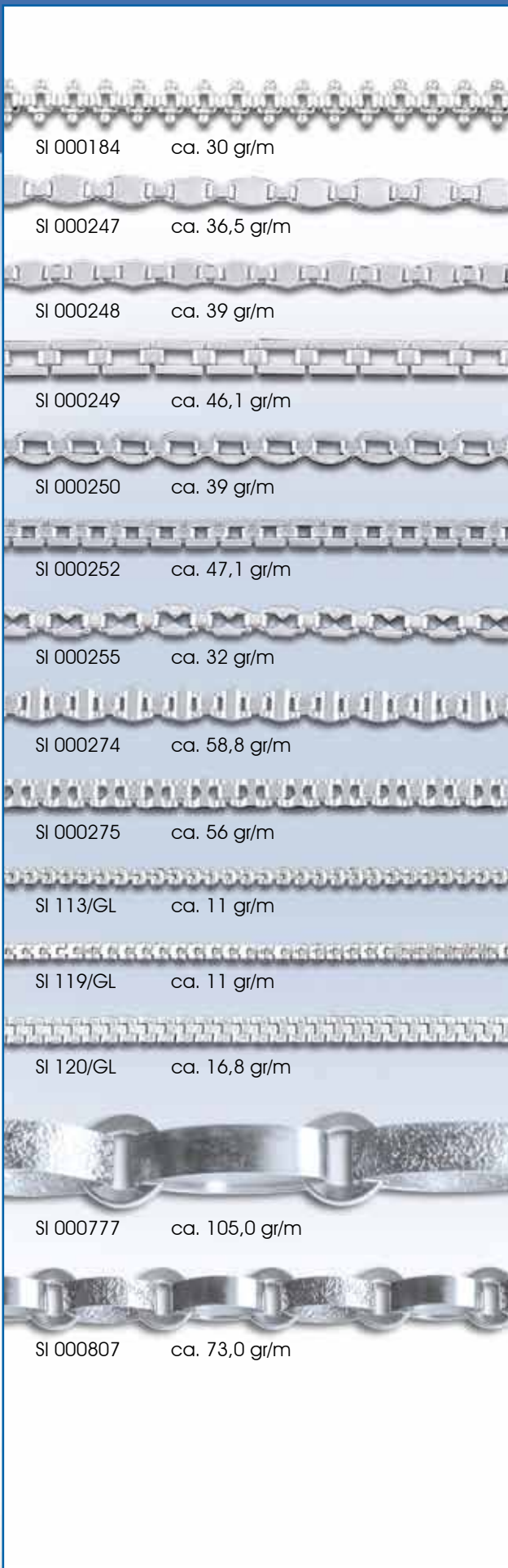

Anhänger / Charms /  
pendentifs



SI ANH A  
ca. 3,6 gr/  
Stk./piece/pièce



SI ANH B  
ca. 4 gr/  
Stk./piece/pièce



SI ANH C  
ca. 2,8 gr/  
Stk./piece/pièce



SI ANH D  
ca. 3,4 gr/  
Stk./piece/pièce



SI ANH E  
ca. 3 gr/  
Stk./piece/pièce



SI ANH F  
ca. 2,8 gr/  
Stk./piece/pièce



SI ANH G  
ca. 3,3 gr/  
Stk./piece/pièce



SI ANH H  
ca. 3,5 gr/  
Stk./piece/pièce



SI ANH I  
ca. 2,3 gr/  
Stk./piece/pièce



SI ANH J  
ca. 3,3 gr/  
Stk./piece/pièce



SI ANH K  
ca. 3,8 gr/  
Stk./piece/pièce



SI ANH L  
ca. 2,8 gr/  
Stk./piece/pièce



SI ANH M  
ca. 3,5 gr/  
Stk./piece/pièce



SI ANH N  
ca. 3,4 gr/  
Stk./piece/pièce



SI ANH O  
ca. 2,8 gr/  
Stk./piece/pièce



SI ANH P  
ca. 3,1 gr/  
Stk./piece/pièce



SI ANH Q  
ca. 3,5 gr/  
Stk./piece/pièce



SI ANH R  
ca. 3,5 gr/  
Stk./piece/pièce



SI ANH S  
ca. 3,1 gr/  
Stk./piece/pièce



SI ANH T  
ca. 2,9 gr/  
Stk./piece/pièce



SI ANH U  
ca. 3,3 gr/  
Stk./piece/pièce



SI ANH V  
ca. 3,4 gr/  
Stk./piece/pièce



SI ANH W  
ca. 3,5 gr/  
Stk./piece/pièce



SI ANH X  
ca. 3,4 gr/  
Stk./piece/pièce



SI ANH Y  
ca. 2,8 gr/  
Stk./piece/pièce



SI ANH Z  
ca. 3,1 gr/  
Stk./piece/pièce

# Anhänger / Charms / pendentifs



SI ANH200  
ca. 2,33 gr/  
Stk./piece/pièce



SI ANH201  
ca. 1,86 gr/  
Stk./piece/pièce



SI ANH202  
ca. 2,33 gr/  
Stk./piece/pièce



SI ANH203  
ca. 3,56 gr/  
Stk./piece/pièce



SI ANH204  
ca. 2,26 gr/  
Stk./piece/pièce



SI ANH205  
ca. 2,31 gr/  
Stk./piece/pièce



SI ANH206  
ca. 1,75 gr/  
Stk./piece/pièce



SI ANH207  
ca. 5,47 gr/  
Stk./piece/pièce



SI ANH208  
ca. 5,28 gr/  
Stk./piece/pièce



SI ANH209  
ca. 1,72 gr/  
Stk./piece/pièce



SI ANH210  
ca. 1,70 gr/  
Stk./piece/pièce



SI ANH211  
ca. 2,00 gr/  
Stk./piece/pièce



SI ANH212  
ca. 2,19 gr/  
Stk./piece/pièce



SI ANH213  
ca. 1,82 gr/  
Stk./piece/pièce



SI ANH214  
ca. 2,80 gr/  
Stk./piece/pièce



SI ANH215  
ca. 3,73 gr/  
Stk./piece/pièce



SI ANH216  
ca. 2,73 gr/  
Stk./piece/pièce



SI ANH217  
ca. 1,37 gr/  
Stk./piece/pièce



SI ANH218  
ca. 2,87 gr/  
Stk./piece/pièce



SI ANH219  
ca. 5,23 gr/  
Stk./piece/pièce



SI ANH220  
ca. 4,79 gr/  
Stk./piece/pièce



SI ANH221  
ca. 1,90 gr/  
Stk./piece/pièce



SI ANH222  
ca. 4,68 gr/  
Stk./piece/pièce



SI ANH223  
ca. 2,33 gr/  
Stk./piece/pièce



SI ANH224  
ca. 1,73 gr/  
Stk./piece/pièce



SI ANH225  
ca. 3,53 gr/  
Stk./piece/pièce



SI ANH226  
ca. 2,3 gr/  
Stk./piece/pièce



SI ANH227  
ca. 2,8 gr/  
Stk./piece/pièce



SI ANH228  
ca. 1,6 gr/  
Stk./piece/pièce



SI ANH229  
ca. 4,95 gr/  
Stk./piece/pièce



SI ANH230  
ca. 2,7 gr/  
Stk./piece/pièce



SI ANH231  
ca. 3,3 gr/  
Stk./piece/pièce



SI ANH232  
ca. 2,0 gr/  
Stk./piece/pièce



SI ANH233  
ca. 3,61 gr/  
Stk./piece/pièce



SI ANH234  
ca. 5,51 gr/  
Stk./piece/pièce



SI ANH235  
ca. 5,51 gr/  
Stk./piece/pièce



SI ANH236  
ca. 1,71 gr/  
Stk./piece/pièce



SI ANH237  
ca. 3,62 gr/  
Stk./piece/pièce



SI ANH239  
ca. 2,4 gr/  
Stk./piece/pièce



SI ANH240  
ca. 2,5 gr  
Stk./piece/pièce



SI ANH241  
ca. 2,4 gr  
Stk./piece/pièce



SI ANH242  
ca. 2,25 gr  
Stk./piece/pièce



SI ANH243  
ca. 3,6 gr  
Stk./piece/pièce



SI ANH244  
ca. 2,0 gr  
Stk./piece/pièce



SI ANH245  
ca. 3,2 gr  
Stk./piece/pièce



SI ANH246  
ca. 2,2 gr  
Stk./piece/pièce



SI ANH247  
ca. 3,0 gr  
Stk./piece/pièce



SI ANH248  
ca. 3,45 gr  
Stk./piece/pièce



SI ANH249  
ca. 2,95 gr  
Stk./piece/pièce



SI ANH250  
ca. 1,25 gr  
Stk./piece/pièce



# Anhänger / Charms / pendentifs



SI ANH301  
ca. 0,95 gr/  
Stk./piece/pièce



SI ANH302  
ca. 2,15 gr/  
Stk./piece/pièce



SI ANH303  
ca. 3,15 gr/  
Stk./piece/pièce



SI LP1  
ca. 0,25 gr  
Stk./piece/pièce



SI LP2  
ca. 0,52 gr/  
Stk./piece/pièce



SI LP3  
ca. 0,29 gr  
Stk./piece/pièce



SI LP4  
ca. 0,34 gr  
Stk./piece/pièce



SI LP5  
ca. 0,43 gr  
Stk./piece/pièce



SI LP6  
ca. 0,57 gr  
Stk./piece/pièce



SI LP7  
ca. 0,78 gr  
Stk./piece/pièce



SI LP8  
ca. 1,0 gr  
Stk./piece/pièce



SI LP9  
ca. 1,75 gr  
Stk./piece/pièce



SI LP10  
ca. 2,15 gr  
Stk./piece/pièce



SI Z959  
ca. 0,61 gr  
Stk./piece/pièce



SI Z960  
ca. 0,63 gr  
Stk./piece/pièce

# Anhänger / Charms / pendentifs

In sich voll beweglich! Completely movable! Entièrement articulés!



SI ANH100  
ca. 14,60 gr/  
Stk./piece/pièce



SI ANH101  
ca. 5,20 gr/  
Stk./piece/pièce



SI ANH102  
ca. 5,20 gr/  
Stk./piece/pièce



SI ANH103  
ca. 4,30 gr/  
Stk./piece/pièce



SI ANH104  
ca. 5,10 gr/  
Stk./piece/pièce



SI ANH105  
ca. 3,70 gr/  
Stk./piece/pièce



SI ANH105/A  
ca. 4,4 gr/  
Stk./piece/pièce



SI ANH106  
ca. 6,00 gr/  
Stk./piece/pièce



SI ANH107  
ca. 4,30 gr/  
Stk./piece/pièce



SI ANH108  
ca. 6,80 gr/  
Stk./piece/pièce



SI ANH109  
ca. 5,80 gr/  
Stk./piece/pièce



SI ANH110  
ca. 4,80 gr/  
Stk./piece/pièce



SI ANH111  
ca. 6,70 gr/  
Stk./piece/pièce



SI ANH115  
ca. 2,10 gr/  
Stk./piece/pièce



SI ANH116  
ca. 2,00 gr/  
Stk./piece/pièce



SI ANH112  
ca. 8,30 gr/  
Stk./piece/pièce



SI ANH113/K  
ca. 1,80 gr/  
Stk./piece/pièce



SI ANH114/K  
ca. 3,5 gr/  
Stk./piece/pièce



SI ANH117  
ca. 5,10 gr/  
Stk./piece/pièce



SI Z/Charmträger  
ca. 2,2 gr/  
Stk./piece/pièce

# Brisuren / Pierced Ear Fittings / essayages d'oreille percés



SI OR  
ca. 0,30 gr/  
Paar/pair/paire



SI OR/1009  
ca. 0,55 gr/  
Paar/pair/paire



SI OR/1010  
ca. 0,44 gr/  
Paar/pair/paire



SI OR/1011  
ca. 0,76 gr/  
Paar/pair/paire



SI OR/1020  
ca. 0,79 gr/  
Paar/pair/paire



SI OR/1021  
ca. 0,79 gr/  
Paar/pair/paire



SI OR/1022  
ca. 0,76 gr/  
Paar/pair/paire



SI OR/1023  
ca. 0,79 gr/  
Paar/pair/paire



SI OR/1024  
ca. 0,77 gr/  
Paar/pair/paire



SI OR/1025  
ca. 0,82 gr/  
Paar/pair/paire



SI OR/1026  
ca. 0,80 gr/  
Paar/pair/paire



SI OR/1027  
ca. 0,76 gr/  
Paar/pair/paire



SI OR/1028  
ca. 0,79 gr/  
Paar/pair/paire



SI OR/1030  
ca. 0,70 gr/  
Paar/pair/paire



SI OR/16  
ca. 0,66 gr/  
Paar/pair/paire



SI OR/1000  
ca. 0,14 gr/  
Paar/pair/paire



SI OR/1001  
ca. 0,29 gr/  
Paar/pair/paire

## Karabiner / lobster clasps / mousquetons

drehbar / turnable / tournant



SI Z909/15MM  
ca. 1,5 gr/  
Stk./piece/pièce



SI Z909/17MM  
ca. 2,0 gr/  
Stk./piece/pièce



SI Z909/20MM  
ca. 4,4 gr/  
Stk./piece/pièce



SI Z909/22MM  
ca. 5,5 gr/  
Stk./piece/pièce



SI Z454  
ca. 0,94 gr/  
Stk./piece/pièce



SI Z453  
ca. 1,32 gr/  
Stk./piece/pièce



SI Z2/10MM  
ca. 0,3 gr/  
Stk./piece/pièce



SI Z2/12MM  
ca. 0,6 gr/  
Stk./piece/pièce



SI Z2/15MM  
ca. 0,9 gr/  
Stk./piece/pièce



SI Z2/16MM  
ca. 1,4 gr/  
Stk./piece/pièce



SI Z916/17MM  
ca. 1,6 gr/  
Stk./piece/pièce



SI Z916/19MM  
ca. 2,8 gr/  
Stk./piece/pièce

# Karabiner / lobster clasps / mousquetons



SI Z912/11MM  
ca. 0,9 gr/  
Stk./piece/pièce



SI Z912/13MM  
ca. 1,5 gr/  
Stk./piece/pièce



SI Z912/16MM  
ca. 2,3 gr/  
Stk./piece/pièce



SI Z912/17MM  
ca. 2,6 gr/  
Stk./piece/pièce



SI Z912/20MM  
ca. 3,8 gr/  
Stk./piece/pièce



SI Z912/22,5MM  
ca. 5,4 gr/  
Stk./piece/pièce



SI Z25/8MM  
ca. 0,22 gr/  
Stk./piece/pièce



SI Z25/9MM  
ca. 0,5 gr/  
Stk./piece/pièce



SI Z25/11MM  
ca. 0,6 gr/  
Stk./piece/pièce



SI Z25/13MM  
ca. 0,9 gr/  
Stk./piece/pièce



SI Z25/16MM  
ca. 1,5 gr/  
Stk./piece/pièce



SI Z25/18MM  
ca. 2,5 gr/  
Stk./piece/pièce



SI Z910/12MM  
ca. 1,0 gr/  
Stk./piece/pièce



SI Z910/14MM  
ca. 1,6 gr/  
Stk./piece/pièce



SI Z910/16MM  
ca. 2,0 gr/  
Stk./piece/pièce



SI Z911/HERZ  
ca. 1,2 gr/  
Stk./piece/pièce



SI Z911/14MM  
ca. 2,3 gr/  
Stk./piece/pièce



SI Z913/9MM  
ca. 0,3 gr/  
Stk./piece/pièce



SI Z913/11MM  
ca. 0,6 gr/  
Stk./piece/pièce



SI Z913/12MM  
ca. 0,9 gr/  
Stk./piece/pièce



SI Z913/16MM  
ca. 1,4 gr/  
Stk./piece/pièce



SI Z924  
ca. 5,8 gr/  
Stk./piece/pièce



SI Z937/14MM  
ca. 1,18 gr/  
Stk./piece/pièce



SI Z937/19MM  
ca. 2,48 gr/  
Stk./piece/pièce



SI Z937/22MM  
ca. 3,62 gr/  
Stk./piece/pièce



SI Z925  
ca. 5,4 gr/  
Stk./piece/pièce



SI Z927  
ca. 5,9 gr/  
Stk./piece/pièce



SI Z919/15MM  
ca. 1,65 gr/  
Stk./piece/pièce



SI Z919/19MM  
ca. 3,0 gr/  
Stk./piece/pièce



SI Z919/26MM  
ca. 5,4 gr/  
Stk./piece/pièce



SI Z926/18MM  
ca. 1,7 gr/  
Stk./piece/pièce



SI Z926/20MM  
ca. 2,4 gr/  
Stk./piece/pièce



SI Z926/22MM  
ca. 3,1 gr/  
Stk./piece/pièce



SI Z926/23,5MM  
ca. 3,8 gr/  
Stk./piece/pièce



SI Z926/27MM  
ca. 4,9 gr/  
Stk./piece/pièce



SI Z926/30MM  
ca. 6,6 gr/  
Stk./piece/pièce

Fordern Sie unsere Kataloge an!  
Please, ask for our catalogues!  
S'il vous plaît demandez nos catalogues!



**Silberschmuck-Großhandel**

Inh. S. Khan

Lärchenstr. 80

65933 Frankfurt aM.

☎ +49 69 3535 6937

☎ +49 173 3138576

☎ +49 177 7875532

✉ [info@ks-silber-schmuck.de](mailto:info@ks-silber-schmuck.de)

🌐 [www.ks-silber-schmuck.de](http://www.ks-silber-schmuck.de)